

QA SERIES

QA 1004 | QA 2004 | QA 3004 | QA 4004

POWER AMPLIFIERS
user manual



Contents

Safety	02-03
Introduction to QA Series	04
Connections	05
Amplifier installation information	06-07
Installation procedure	08-09
System configuration diagrams	09-10
Specifications	11

Safety Precautions



Carefully read the user manual fully prior to use. Improper use can cause damage to the amplifier and any speakers attached to it. Please be aware of correct wiring and configurations as directed in the Installation section of this manual.



Do not attempt to clean any plastic parts with solvents or petrochemical based cleaners.



The power voltages inside this device are high and could cause serious injury or death if touched while the power is connected. Do not open the amplifier case as there are no user serviceable parts inside.



Installation allowing direct precipitation is not advised and installation practise **must** prevent liquids from entering the box.



Do not place sources of heat on or around the amplifier such as lighting equipment or smoke machines, and where possible please keep out of direct sunlight.



Do not place magnetic sensitive equipment on or around amplifiers



Installation Precautions

1. Read all the documentation accompanying your amplifier before operating.
2. Make absolutely sure the power supply is wired correctly. This can be done with a commercially available power supply tester. This especially applies to three-phase distribution boards where an incorrectly wired or intermittent neutral line can cause excessive voltages causing permanent damage to any 230-110 volt equipment connected to it. It is good practice to test the power for polarity and voltage range. Faulty wiring is commonly the source of many audio difficulties.
3. Always operate the amplifier with the earth or ground connected. When powered from a generator, make sure there is a viable earth connection.
4. Check that the external power wiring is in good condition. Do not connect to damaged or frayed wiring.
5. Confirm that the amplifier outputs are correctly connected before operating. This particularly applies to multiple speaker arrays here incorrect wiring can lead to an accidental parallel connection to another amplifier's output causing damage to both amplifiers.
6. Do not locate amplifiers close to sources of heat or moisture.
7. Keep air intake area clear. It is good practice to clean filter regularly and occasionally check the amplifier is not clogged with dust. A hot amplifier rack is a sign of inadequate maintenance or poor installation.
8. Occasionally check the cooling fans are functioning. If an amplifier shuts down as a result of excessive heat, distorts or is not sounding as it should, check the speaker wiring, power supply, (too low or too high), fan operation and input gain structure for non standard setup.
9. Check your amplifier rack is clear of loose cable ties, screws and stray wires that can obstruct fans or allow entry of anything that can cause short circuit.
10. The amplifier should be returned to Quest Audio service centre for service by qualified personnel if service is required.
11. Output voltages from the QA Series are potentially high. Use only well insulated quality speaker cable of suitable gauge. (See section covering installation and wiring recommendations)

Register Your Product

Thank you for choosing Quest. Please take the time to complete your product registration card which is included with the packaging. Registering your Quest Engineering product will:

- CONFIRM YOUR WARRANTY
- REGISTER YOUR PRODUCT
- PROTECT YOUR NEW PRODUCT

Quest QA Series Power Amplifiers

Introduction

Congratulations on your purchase of a new QA Series professional power amplifier. Quest Engineering QA Series amplifiers are engineered and built to a standard that will satisfy the most demanding environments of both mobile live sound and permanent installation audio.

For your safety and continuing reliability of your Quest amplifier, please read all the safety instructions and familiarise yourself with the amplifiers functions and installation procedure section before installing and operating the amplifier.

Attention to detail

In order to maintain strict quality assurance standards, all QA Series amplifiers are built and tested in Quest Engineering's own manufacturing facility. Electronic components are the finest grade available, and sub-assemblies are tested at every stage before final assembly. Each amplifier is then subjected to stress testing before shipping.

It follows that if your audio installation is completed with the same attention to detail, your amplifier will deliver its best results. It is recommended to make sure all the mixers and signal processors in the signal chain to the amplifier are set correctly. Clean un-distorted power will not just sound better; it will also help your speakers give you a long service life.

Unpacking

Please inspect the amplifier carefully immediately after unpacking. If you find any damage, notify your supplier/dealer immediately. Only the shipper may file a damage claim with the carrier for damage incurred during shipping. Be sure to save the carton and all packing materials for the carrier's inspection.

If your packing materials are in good condition, please save them. If you ever need to ship the unit back to Quest Engineering or an authorised service centre, you are advised to use the original factory packing.

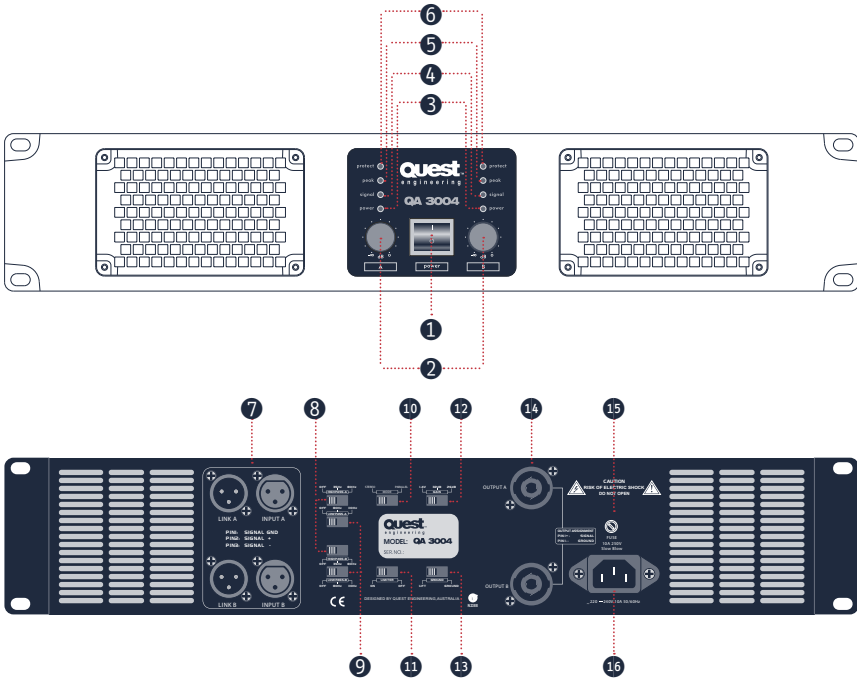

1. ON/OFF Switch.
2. LEVEL Control of the input level of the external signal in 3dB increments.
3. POWER Status available.
4. SIGNAL Signal status indicators: These LEDs indicate signal presence for both the inputs of channel A and B.
5. PEAK Status indicates when amplifier is approaching clipping.
6. PROTECT The protect LED indicates that one of the various amplifier protection circuits has been activated.*If LED remains on please return amplifier to a certified service technician.
7. INPUTS Channel A/B balanced XLR inputs: pin 1 ground, pin 2 + and pin 3 -
8. HIGH PASS FILTER Selectors for A & B.
9. LOW PASS FILTER Selectors for A & B.
10. MODE This switches amplifier operational mode from Stereo/Parallel Mono Input is across channel Please refer to page 7 of this manual for correct wiring instructions.
11. LIMITER Switches between off and on.
12. GAIN Input switch to calibrate mixer line level to amplifier input sensitivity.
13. GROUND Separates electrical earth from that of chassis ground.
14. OUTPUTS Channel A/B Speakon NL4 connectors output on pin1+ and 1-
15. Fuse (Main Power) If the fuse is blown the output stage is most likely damaged. Replace fuse once with the correct fuse and of it blows again, the amplifier should be sent to an authorised repairer for checking. Fuse type is T10A -250V slow blow
16. MAINS INPUT Main power input IEC.

Notes for better amplifier performance

• Amplifier gain

The amplifier should always be operated with the input level controls set at maximum. The only departure from this practice is where the internal filters/crossover is engaged in a bi-amp configuration, where it may be necessary to turn down the high frequency side of the amplifier. If the amplifier needs to be calibrated, to match a mixer line level output, the gain switch on the back of the amplifier can be switched to the correct line level.

The objective of correct gain settings is to have all the segments of the audio chain from the preamplifier/equalisers/compressors/crossovers matched to the amplifier. A test tone should take every link in the chain to 0 dB or +4 dB at the same input level. This way, a mixer VU indicator is a real visual clue as to how hard the whole system is running and no single element will be adding distortion before the system is at full power.

• High- and low-pass filters

The filter system in a QA series amplifier is a basic switchable high/low pass crossover. It can also be used to filter out sub-harmonic low bass frequencies the speaker system cannot reproduce and waste amplifier power. It is particularly recommended to switch in the 35 Hz High Pass filter when the amplifier is being used to power band-pass type bass boxes.

The amplifier can be used to power a bass system without the need for an electronic crossover by switching the high-pass to 35Hz and the low-pass to 80 or 110Hz. The input link A/B XLR connectors at the back of the amplifier will remain full-range, so a full-range signal can be daisy chained to another amplifier or powered speaker.

• Amplifier limiter

The switchable limiter is designed to prevent the amplifier from clipping or distorting, there by causing speaker damage. It should always be engaged except in the circumstance where the amplifier is being used in conjunction with an amplifier sensing speaker system controller.

Some brands of speaker system are designed to be monitored and controlled by a dedicated system controller that is wired directly to the output of the amplifier. These systems measure both the input and output from the amplifier and monitor the signal for best results from the speaker system. To engage the amplifier's limiter will interfere with the controllers sensing circuit, so the amplifier limiter must be disengaged.

• The air intakes

The two filtered air intakes have removable filters for cleaning. The air intakes should be unobstructed and allow the free flow of air.

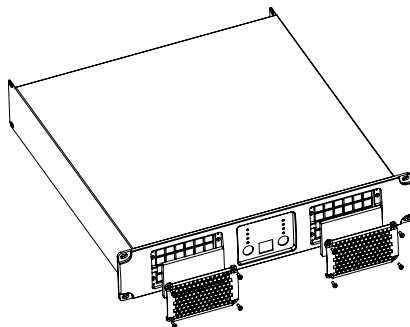

The filters should be removed and cleaned as needed. Running the amplifier without the filters will allow the amplifier to fill with dust and foreign particles and could void the warrantee under some circumstances.

• Rack-mounting amplifiers for the road
The chassis of the QA series is fabricated from Q235 Cold Steel Rolling and is quite durable. However, suspending an amplifier in free space in a rack and then vibrating in the back of a truck for long rough journeys may cause fatigue to the front panel mounting. It is essential that the amplifier be supported from the front and rear in rack-mounting especially when the amplifier rack is to be transported. Failure to install correctly may void warranty. **IMPORTANT:** Clean air filters regularly and always allow adequate ventilation and do not block air flow to amplifier!

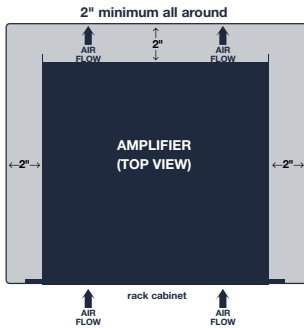

Parallel Mono is selected when you have an odd number of speakers, such as three. Instead of leaving the amplifier in stereo two-channel mode and driving two on one side and one on the other. By selecting Parallel Mono you can parallel all three and drive them with equal power when connected to either or both speaker outputs. Parallel mono is also more desirable for the amplifier for speaker loads of 3-4Ω.

Care must be taken with speaker connections to never have the amplifier outputs joined together by a daisy chain of speaker connections. In this configuration channel A level control is also used to control amplifier level.

- Recommendations for speaker cables
Speaker cable needs to be as heavy gauge as conveniently possible for low-loss results.

Light gauge cable (below 1.5mm) will create extra resistance and waste amplifier power—this particularly applies to long speaker runs. The damping factor statistic (“punch” for the non technical) is greatly diminished so keep your speaker cables short and fat. Quality microphone cable will also lower noise and improve high frequency response

Using the guidelines below, select the appropriate size of wire based on the distance from amplifier to speaker

distance	wire size	indicative
up to 25 ft	16AWG	=====
25-40 ft	14AWG	=====
41-60 ft	12AWG	=====
61-100 ft	10AWG	=====
101-150 ft	8AWG	=====
151-250 ft	6AWG	=====

CAUTION: Never use shielded cable for output wiring

Installation Procedure

Mains Power Connection

Before connecting the amplifier to the mains power, make certain that the voltage corresponds with that indicated on the rear of the amplifier. A variation of 10% is acceptable. Refer to safety warnings before switching on.

Power Up

It is standard procedure to power up the amplifiers last and shut down first. The QA series amplifiers feature turn on delays as the power up diagnostic circuits search for faults, so turn on “thump” is avoided. The speaker outputs are switched into circuit once checks are complete and normal operating voltages are present at all stages of the amplifier.

When powering up multiple amplifiers, a staged turn on is suggested as the power surge of simultaneously switching on multiple amplifiers can exceed the power supply capability causing circuit breakers to disengage.

Power Requirements

The QA Series amplifier is capable of high output voltages. When multiple amplifiers will be operating simultaneously, make sure the power supply is adequate for all amplifiers to draw full power. In this case three phase power of sufficient Amperage supply capacity will give best results from your amplifiers.

In the case where power is to be supplied from mobile generators, it may help to “load the generator” with some lighting to create a reserve of power from the generator for the amplifiers. Amplifiers do not necessarily draw high continuous power as lighting will, but have a high demand for dynamic power and can draw very high amounts of current for short durations. If the power is not available, distortion and reduced performance will result.

Rack mount installation

In permanent installation or mobile rack mounting it is recommended to secure the amplifier from both front and rear rack mounting facilities. For mobile application, this practice is absolutely essential. Damage to the amplifier caused by incorrect rack mount installation or transit damage is not covered by the warrantee.

Installation and electrical interference

Avoid installing your amplifier near sources of magnetic fields such as radio transmitters, welding equipment,

high current transformers, lighting dimmers or electric motors.

All signal cables should be physically isolated from power cables and all audio and amplifier power should be supplied via a circuit separate from lighting or stage machinery power. Failure to observe this standard may generate unwanted noises and hum to the audio system.

Connecting cables

When connecting the audio system, use only balanced three conductor signal cable of high quality (screen pin1 plus two signal carriers pin2/3). Low cost cable is more inclined to pick up radio frequencies and noise under certain conditions. For speaker cabinets, always use two core copper high current cables of suitable length. The thicker the copper core, the less the loss on a long speaker line.

It follows to not make speaker cable runs longer than necessary. Long runs of thin cable will greatly reduce the excellent damping factor of the QA series amplifiers causing a loss of “punch” in the bass response. The rule of thumb is to use as thick a copper core as is practical. It is impossible for a cable to have too much copper but too little will cause losses of power and reduced damping factor. Unnecessarily long speaker cable runs will have the same effect, especially when left in a tight coil from a high powered amplifier.

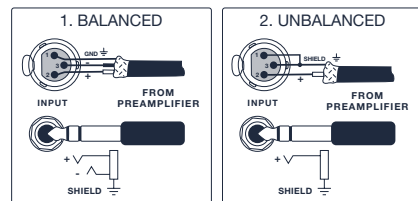

1. Balanced input connector wiring.
2. Unbalanced input connector wiring.

System configuration diagrams

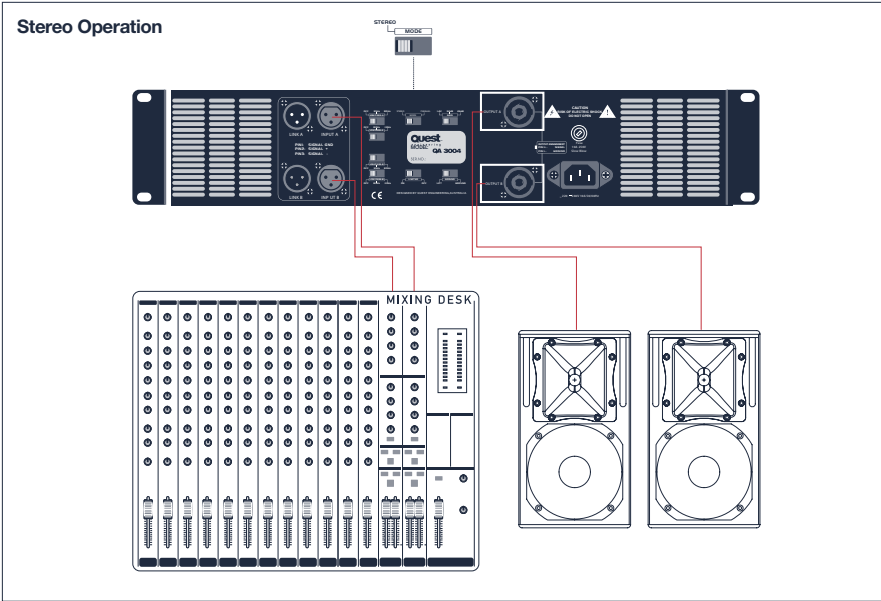

INSTALLATION

Parallel-Mono Operation



SWITCH AMPLIFIER OFF BEFORE ENGAGING MONO SWITCH
OR SERIOUS AMPLIFIER DAMAGE WILL RESULT

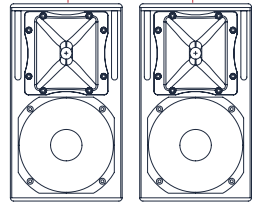
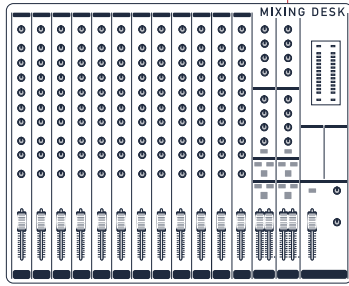

Quest Engineering QA Series Amplifiers: Specifications*

	QA 1004	QA 2004	QA 3004	QA 4004
Rated Power (2 x 8 Ohms)	290 W per channel @ 1 kHz at <0.1% T.H.D.both channels driven	490 W per channel @ 1 kHz at <0.1% T.H.D. both channels driven	660 W per channel @ 1 kHz at <0.05% T.H.D. both channels driven	1,090 W per channel @ 1 kHz at <0.05% T.H.D. both channels driven
Rated Power (2 x 4 Ohms)	575 W per channel @ 1 kHz at <0.1% T.H.D.both channels driven	870 W per channel @ 1 kHz at <0.1% T.H.D. both channels driven	1100 W per channel @ 1 kHz at <0.05% T.H.D. both channels driven	2,000 W per channel @ 1 kHz at <0.05% T.H.D. both channels driven
T.H.D.	<0.1% @250 W per channel from 20 HZ to 20 kHz	>0.1% @ 400 W per channel from 20 Hz to 20 kHz		>0.5% @ 400 W per channel from 20 Hz to 20 kHz
Minimum Load Impedance		4 Ohms – sine wave		4 Ohms – sine wave
Phase Response		+5 to -15 from 20 Hz to 20 kHz		+20 to -25 from 20 Hz to 20 kHz
Input Impedance		20k Ohms, balanced; 10k Ohms, unbalanced		20k Ohms balanced 10k Ohms unbalanced
Cooling		Two temperature dependant variable speed 80mm high output DC fans		Two temperature dependant variable speed 120mm high output DC fans
Controls		Two front panels attenuators, rear panel mode switch and gain select switch		Two front panels attenuators, rear panel mode switch and gain select switch
Hi Pass: Linkwitz-Reily (24 db/Octave)		Off/35/80 Hz		Off/35/80 Hz
Low Pass: Linkwitz-Reily (24 db/Octave)		Off/80/110 Hz		Off/80/110 Hz
Voltage Gain @ 0.775V	29 dB or 24 dB	32 dB or 26 dB	35 dB or 29 dB	38 dB or 32 dB
Crosstalk	>-60 dB @ 1 kHz at rated power @ 8 Ohms		>-60 dB @ 1 kHz at rated power @ 8 Ohms	>-60 dB @ 1 kHz at rated power @ 8 Ohms
Hum and Noise	>-105 dB, "A" weighted referenced to rated power @ 8 Ohms	>-107 dB, "A" weighted referenced to rated power @ 8 Ohms	>-107 dB, "A" weighted referenced to rated power @ 8 Ohms	>-104 dB, "A" weighted referenced to rated power @ 8 Ohms
Slew Rate	>30V/us		>40V/us	>44V/us
Damping Factor (8 Ohms)	>500:1 @ 20 Hz - 1 kHz	>700:1 @ 20 Hz - 1 kHz		>800:1 @ 20 Hz - 1 kHz
Protection		Thermal, DC, turn-on bursts, subsonic, incorrect loads		Thermal, DC, turn-on bursts, subsonic, incorrect loads
Connectors		XLR, Speakon speaker output, 240/230 V 16 amps IEC mains		XLR, Speakon speaker output, 240/230 V 20 amps IEC mains
Construction		Cold Steel Rolling + Machined aluminium front panel		Cold Steel Rolling + Machined aluminium front panel
Dimensions		89 x 483 x 496 mm		132 x 483 x 496 mm
Net Weight	17 kg	21 kg	23 kg	35 kg
Packaged Shipping Weight	20 kg	23 kg	26 kg	38 kg

* All specifications are correct at time of printing, Quest Engineering reserves the right to change specifications at any time and won't be held responsible for any typographic errors in this publication.



www.questaudio.net